



CTINCA



**A universe
of possibilities...**



Novas tecnologias para acabamentos.
High-tech finishing technologies.

4-5

NEW COLLECTIONS - CERSAIE 2023

CONCRETE EFFECT	POWERCRETE	6 - 7
CONCRETE EFFECT	RETRO	8 - 9
STONE EFFECT	SLATE	10 - 11
WOOD EFFECT	CHALET	12 - 13
MARBLE EFFECT	ONYX - DEEP ONYX	14 - 15
MARBLE EFFECT	ONYX - BLING	16 - 17
MARBLE EFFECT	ONYX - NATURA	18 - 19
COTTO EFFECT	BRICKWORK	20 - 21
COLOUR	CHROMA	22 - 23

The best technology exists when focus is on what's more important.



EASY CLEANING

Toque Suave · Estética · Praticidade · Segurança

Soft Touch · Aesthetic · Practicality · Safety

ANTIDERRAPANTE TECNOLOGIA FÁCIL LIMPEZA

Perfeitos para aplicar em espaços onde se preveja: ALTO TRÁFEGO, MANUTENÇÃO EXIGENTE e seja necessário GARANTIR O CONFORTO DO PÉ DESCALÇO.

SLIP-RESISTANT EASY CLEANING TECHNOLOGY

Perfect to apply in spaces where: HIGH TRAFFIC, DEMANDING MAINTENANCE is expected and it's necessary to GUARANTEE BAREFOOT COMFORT.

Recomendado para:

**EXTERIORES
BALNEÁRIOS
INSTITUIÇÕES DE SAÚDE
ESCOLAS
HOTELARIA**

Especially recommended for:

**OUTDOORS
SPAS
HEALTH-CARE CENTRES
SCHOOLS
RETAIL FOOD COURTS**



CLEAN & PROTECT

Ecológico

Pavimentos e revestimentos cerâmicos tornam-se mais seguros sem a utilização de químicos perigosos.

Auto Esterilização

A presença de substâncias orgânicas assim como bactérias e fungos são largamente reduzidos na superfície cerâmica.

Superhidrofílica Ação Contínua

Permite que manchas de óleo possam ser facilmente lavadas com água. As superfícies são melhor preservadas contra sujidade e manchas.

Purificação do Ar Decompõe Odores

Também funciona como purificador de ar que decompõe substâncias orgânicas, ajudando a reduzir a poluição do ar.

Recomendado para:

**INSTITUIÇÕES DE SAÚDE
LARES DE TERCEIRA IDADE
ESCOLAS
HOTELARIA**

Testes de Normas Internacionais

Teste Antibacteriano (ISO 27447):
redução de mais de 95% de colónias de bactérias no espaço de 4 horas

Teste Antifungos (ISO 27447):
redução de mais de 85% de colónias de fungos no espaço de 4 horas

Observações:
Quantidades mínimas requeridas para encomenda.
Por favor contacte-nos para mais informações.

Environmentally Friendly

Surfaces become safer without the use of dangerous chemicals.

Self Sterilizing

The presence of organic substances as well as bacteria and fungus are largely reduced on ceramic surfaces.

Superhydrophilic Continuous Action

Enable oil spots to be swept away easily with water. Surfaces are better preserved from dirt and stains.

Air Purification Decomposes Odours

The coating also works as an air purifier decomposing organic substances, helping to lower air pollution..

Especially recommended for:

**HEALTH-CARE CENTRES
ELDERLY DAY-CARE CENTRES
SCHOOLS
RETAIL FOOD COURTS**

International Standard Testing

Antibacterial test (ISO 27447):
more than 95% bacterial colony reduction within 4 hours

Antifungal test (ISO 27447):
more than 85% fungal colony reduction within 4 hours

Please note:
Minimum quantities required for order.
Please contact us for more information.



POWERCRETE





Trazer à vida um material inerte, onde a passagem do tempo está belamente marcada e a sua mutabilidade, a do cimento, nos conquista demoradamente...

Bring an inert material to life, where the passage of time is beautifully marked, and the cement mutability conquers us at length.

5 CORES COLOURS

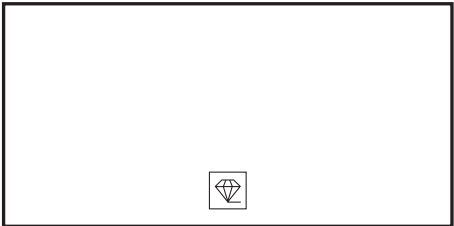
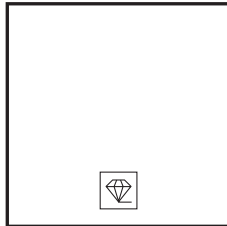
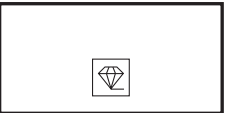
				
BEGE BEIGE	CASTANHO BROWN	CINZA CLARO LIGHT GREY	CINZA GREY	PRETO BLACK
8904	8907	8905	8906	8908

3 FORMATOS SIZES

		
60×120 cm RTFAD 24"×47" RTFAD	60×60 cm RTFAD 24"×24" RTFAD	30×60 cm RTFAD 12"×24" RTFAD
 9 mm 0.35 in	 8 mm 0.32 in	 8 mm 0.32 in

Acabamento: Finishing:  **Antiderrapante** Slip-resistant

MOSAICO 36
MOSAIC 36

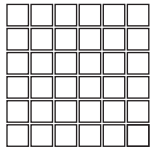

33×33 cm 13"×13"

 8 mm 0.32 in

****/640

MOSAICO MURETO 16
MOSAIC MURETO 16

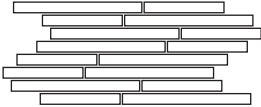

24×49 cm 9"×19"

 8 mm 0.32 in

****/016

PEÇA DEGRAU LINEAR
STEP TREAD

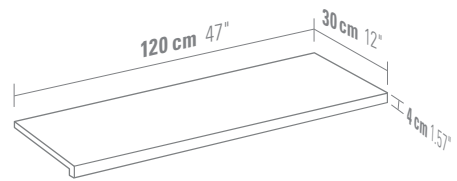

30×120cm RTF PDLAD 12"×47" RTF PDLAD
30×60cm RTF PDLAD 12"×24" RTF PDLAD

RODAPÉ
BULLNOSE

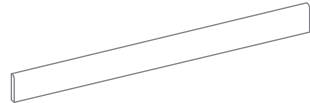

8×120cm RTF ROD 3.15"×47" RTF ROD
8×60 cm RTF ROD 3.15"×24" RTF ROD



RETRO

Adicione um toque urbano à sua casa com um cimento de inspiração industrial-shabby-chic.

Add an urban touch to your home with an industrial-shabby-chic-inspired concrete.

NOVOS REVESTIMENTOS para conjugar com os pavimentos.

NEW WALL TILES to coordinate with the floor tiles.

4 CORES COLOURS



AREIA
SAND

6207

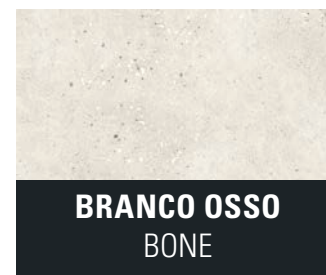

BRANCO OSSO
BONE

6206

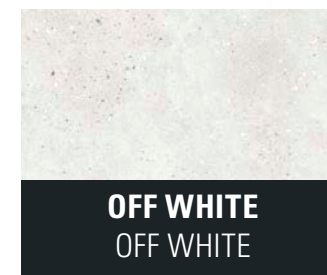

OFF WHITE
OFF WHITE

6205



CINZA
GREY

6208

3 FORMATOS SIZES

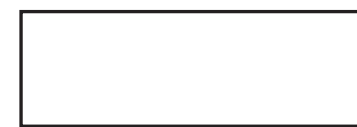

M 25x75 cm 10"×30"

9 mm 0.35 in

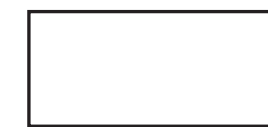

M 25x55 cm 10"×22"

8 mm 0.32 in



7,5x25 cm 3"×10"

8 mm 0.32 in

Acabamento:  **Mate**
Finishing: **Matt**

3 ESTRUTURAS STRUCTURES



WAVE
****/400



RAZOR
****/300



SHAPES
****/950

RODAPÉ
BULLNOSE



7,5x25cm
3"×10"



SPLASH - SLATE

A inconfundível reprodução cerâmica da pedra SLATE, que nos fascina há milénios devido à sua excentricidade, destaca-se de tantas outras: impactante, irreverente e garbosa.

The SLATE stone's unmistakable ceramic reproduction, which has fascinated us for millennia due to its eccentricity, stands out from many others: striking, irreverent and elegant.

NOVOS FORMATOS e NOVA COR - ANTRACITE.
NEW SIZES and NEW COLOUR - ANTHRACITE.

5 CORES COLOURS

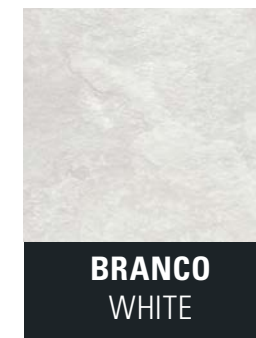

9440

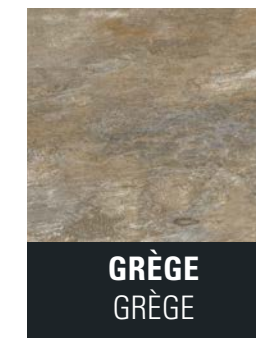

9441



9443

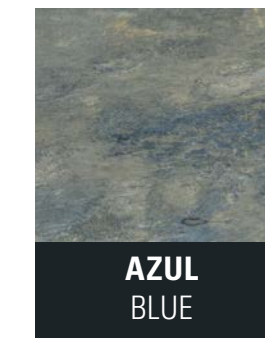

9444



9446

5 FORMATOS SIZES

3 NOVOS NEW

Acabamentos:
Finishings:

NAT Natural

EC Antiderrapante
EASY CLEANING Slip-resistant

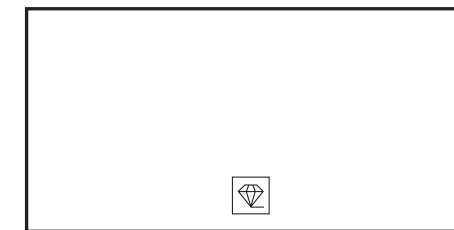

60 × 120 cm RTF 24" × 47" RTF

9 mm 0.35 in

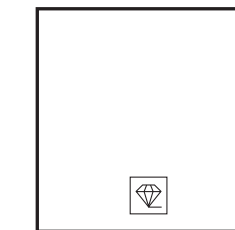

60 × 60 cm RTF 24" × 24" RTF

8 mm 0.32 in



30 × 60 cm RTF 12" × 24" RTF

8 mm 0.32 in

MOSAICO 36
MOSAIC 36

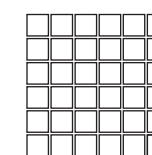

33 × 33 cm 13" × 13"

8 mm 0.32 in

****/640

MOSAICO MURETO 16
MOSAIC MURETO 16

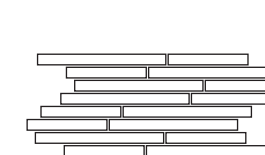

24 × 49 cm 9" × 19"

8 mm 0.32 in

****/016

PEÇA DEGRAU LINEAR
STEP TREAD



30 × 120 cm RTF PDL 12" × 47" RTF PDL
30 × 120 cm RTF PDL AD 12" × 47" RTF PDL AD
30 × 60 cm RTF PDL 12" × 24" RTF PDL
30 × 60 cm RTF PDL AD 12" × 24" RTF PDL AD

RODAPÉ
BULLNOSE

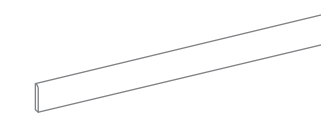

8 × 120 cm RTF ROD 3.15" × 47" RTF ROD
8 × 60 cm RTF ROD 3.15" × 24" RTF ROD



CHALET

A doçura de uma madeira acolhedora, inspirada no majestoso nogueira italiano, e em harmonia com os seus mais belos e suaves atributos.

The gentleness of a welcoming wood, inspired by the magnificent Italian walnut, and in accord with its most pleasing and soft attributes.

6 CORES COLOURS



NATURAL
NATURAL

8764



AMBAR
AMBER

8765



CAMEL
CAMEL

8766



VERMELHO
NATURAL

8767



CINZA
GREY

8768



BRANCO
WHITE

8769

1 FORMATO SIZE

Acabamentos:
Finishings:

NAT

Natural
Natural



Antiderrapante
Slip-resistant

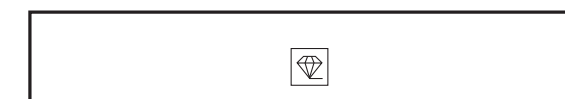

20 x 120 cm RTF 8" x 47" RTF

9 mm 0.35 in

MOSAICO 36
MOSAIC 36
33x33 cm
13" x 13"
****/640

PEÇA DEGRAU LINEAR
STEP TREAD

20 x 120 cm RTF PDL
8" x 47" RTF PDL

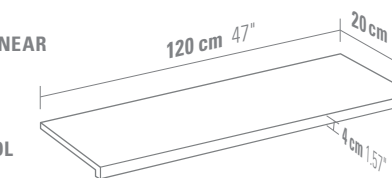

RODAPÉ
BULLNOSE

8 x 120 cm RTF ROD
3.15" x 47" RTF ROD





DEEP ONYX

DEEP ONYX é a reinvenção do mármore ónix no seu maior esplendor, decalcando-o intensamente e pormenorizando a sua beleza de forma excêntrica. DEEP ONYX is the reinterpretation of onyx marble in its most unforgettable splendor by tracing it intensely and detailing its beauty eccentrically.

5 CORES COLOURS

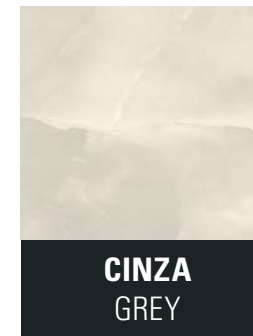

CINZA
GREY

WALL 6225
FLOOR 8645



OSSO
BONE

WALL 6226
FLOOR 8646

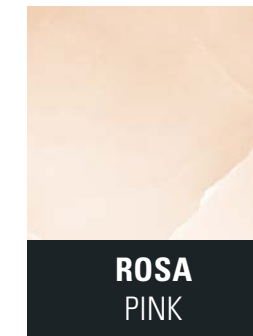

ROSA
PINK

WALL 6227
FLOOR 8647

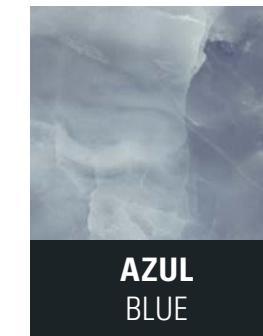

AZUL
BLUE

WALL 6228
FLOOR 8648

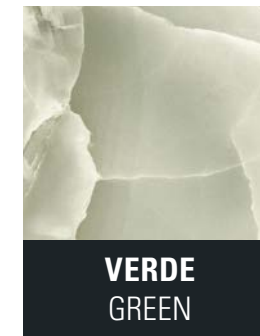

VERDE
GREEN

WALL 6229
FLOOR 8649

3 FORMATOS PAVIMENTO FLOOR TILES SIZES

Acabamentos: NAT **Natural**
Finishings: Natural

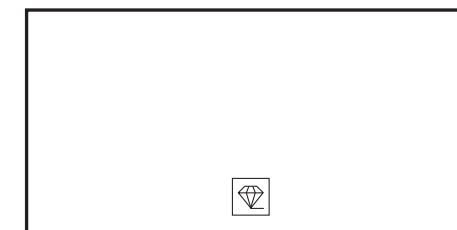

60×120 cm RTF 24"×47" RTF

9 mm 0.35 in

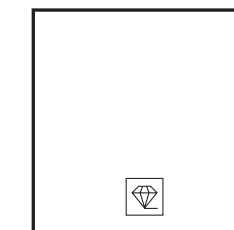

60×60 cm RTF 24"×24" RTF

8 mm 0.32 in

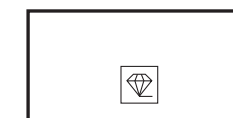

30×60 cm RTF 12"×24" RTF

8 mm 0.32 in

3 FORMATOS REVESTIMENTO WALL TILES SIZES

Acabamento: **Brilhante**
Finishing: Glossy

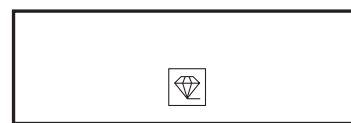

30×90 cm RTF 12"×35" RTF

10 mm 0.39 in



M25×55 cm 10"×22"

8 mm 0.32 in



7,5×25 cm 3"×10"

8 mm 0.32 in

4 ESTRUTURAS STRUTURES

WIND
****/550

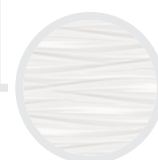
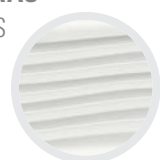

LEAF
****/650

SHAPES
****/950



WAVE
****/400



**RODAPÉ
BULLNOSE**
7,5×25 cm
3"×10"



MOSAICO 36
MOSAIC 36

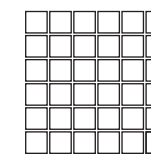

33×33 cm 13"×13"

8 mm 0.32 in

****/640

**MOSAICO MOSAIC
HEX REGULAR**

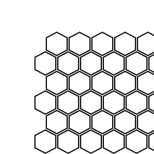

33×30 cm 13"×12"

8 mm 0.32 in

****/720

**MOSAICO MOSAIC
PICKET**



29×29 cm 11.5"×11.5"

8 mm 0.32 in

****/614

**MOSAICO MOSAIC
METRICS**

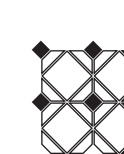

29×29 cm 11.5"×11.5"

8 mm 0.32 in

****/624

PEÇA DEGRAU LINEAR
STEP TREAD

30×120 cm RTF PDL
12"×47" RTF PDL
30×60 cm RTF PDL
12"×24" RTF PDL

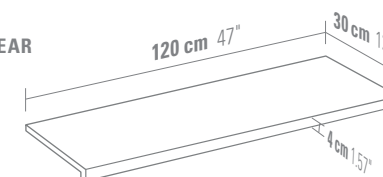

**RODAPÉ
BULLNOSE**

8×120 cm RTF ROD
3.15"×47" RTF ROD
8×60 cm RTF ROD
3.15"×24" RTF ROD





BLING

Finos veios dourados movem-se sobre a superfície cerâmica e definem o ritmo da beleza original do mármore.

Thin golden veins move through the ceramic surface and define the rhythm of the marble's original beauty.

3 CORES COLOURS

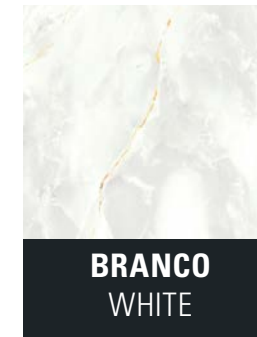

BRANCO
WHITE

WALL 6210
FLOOR 8910

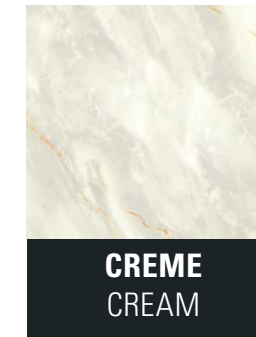

CREME
CREAM

WALL 6211
FLOOR 8911



CINZA MÉDIO
MEDIUM GREY

WALL 6212
FLOOR 8912

3 FORMATOS PAVIMENTO FLOOR TILES SIZES

Acabamentos: NAT **Natural**
Finishings: Natural

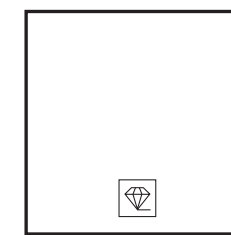

60×60 cm RTF 24"×24" RTF

8 mm 0.32 in

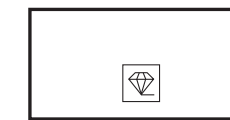

30×60 cm RTF 12"×24" RTF

8 mm 0.32 in

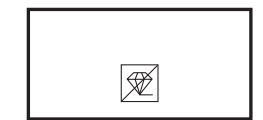

30×60 cm 12"×24"

8 mm 0.32 in

MOSAICO 36
MOSAIC 36

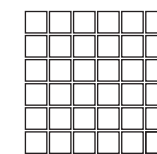

33×33 cm 13"×13"

8 mm 0.32 in

****/640

MOSAICO MOSAIC
HEX REGULAR

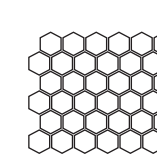

33×30 cm 13"×12"

8 mm 0.32 in

****/720

MOSAICO MOSAIC
PICKET

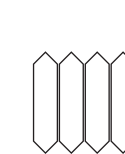

29×29 cm 11.5"×11.5"

8 mm 0.32 in

****/614

MOSAICO MOSAIC
METRICS



****/624

RODAPÉ
BULLNOSE



8×60 cm RTF ROD 3.15"×24" RTF ROD

3 FORMATOS REVESTIMENTO WALL TILES SIZES

Acabamento: **Brilhante**
Finishing: Glossy



M 25×75 cm 10"×30"

9 mm 0.35 in



M 25×55 cm 10"×22"

8 mm 0.32 in



7,5×25 cm 3"×10"

8 mm 0.32 in

3 ESTRUTURAS STRUCTURES



WAVE
****/400

SHAPES
****/950



SHELL
****/750



RODAPÉ
BULLNOSE

7,5×25 cm
3"×10"



MARBLE
EFFECT

MARBLE
EFFECT





NATURA

A suavidade, a pureza e a discreta beleza de um mármore que define a elegância que não se dissolve no tempo.
The softness, the purity, and the discreet beauty of NATURA define an elegance that doesn't disappear over time.

4 CORES COLOURS

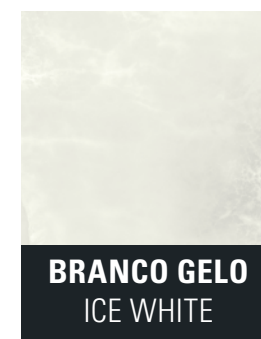

BRANCO GELO
ICE WHITE

WALL 6220
FLOOR 8960

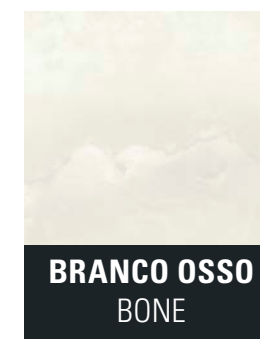

BRANCO OSSO
BONE

WALL 6221
FLOOR 8961

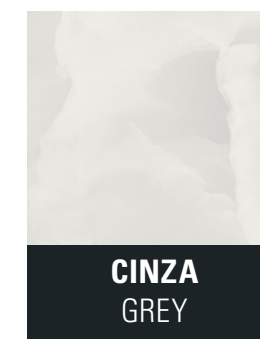

CINZA
GREY

WALL 6222
FLOOR 8962

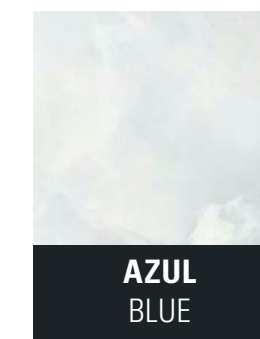

AZUL
BLUE

WALL 6223
FLOOR 8963

3 FORMATOS PAVIMENTO FLOOR TILES SIZES

Acabamentos: NAT **Natural**
Finishings: NAT **Natural**

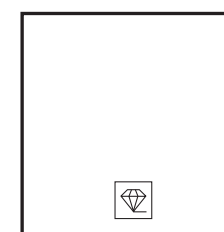

60×60 cm RTF 24"×24" RTF

8 mm 0.32 in

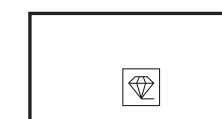

30×60 cm RTF 12"×24" RTF

8 mm 0.32 in



30×60 cm 12"×24"

8 mm 0.32 in

MOSAICO 36
MOSAIC 36

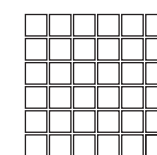

33×33 cm 13"×13"

8 mm 0.32 in

****/640

MOSAICO MOSAIC
HEX REGULAR

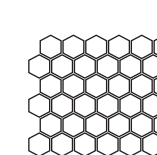

33×30 cm 13"×12"

8 mm 0.32 in

****/720

MOSAICO MOSAIC
PICKET



29×29 cm 11.5"×11.5"

8 mm 0.32 in

****/614

MOSAICO MOSAIC
METRICS

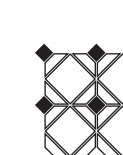

****/624

RODAPÉ
BULLNOSE



8×60 cm RTF ROD 3.15"×24" RTF ROD

3 FORMATOS REVESTIMENTO WALL TILES SIZES

Acabamento: Brillhante
Finishing: Glossy



M 25×75 cm 10"×30"

9 mm 0.35 in



M 25×55 cm 10"×22"

8 mm 0.32 in



7,5×25 cm 3"×10"

8 mm 0.32 in

3 ESTRUTURAS STRUTURES



WAVE
****/400

SHAPES
****/950

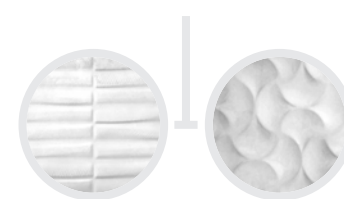

SHELL
****/750



RODAPÉ
BULLNOSE

7,5×25 cm
3"×10"





BRICKWORK

Camadas de bricks repletas de nuances que nos relembram os tradicionais nova-iorquinos expostos nas fachadas centenárias: peças originais (7,5x45 cm), arestas irregulares e superfícies estruturadas que abrigam profundas destonalizações.

Layers of shaded bricks remind us of the traditional New York-style brickwork, exposed on the century-old facades: original tiles (7,5x45 cm), irregular edges and structured surfaces that shelter deep shades.

6 CORES COLOURS

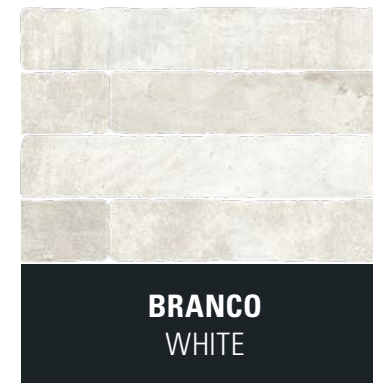

BRANCO
WHITE

8970

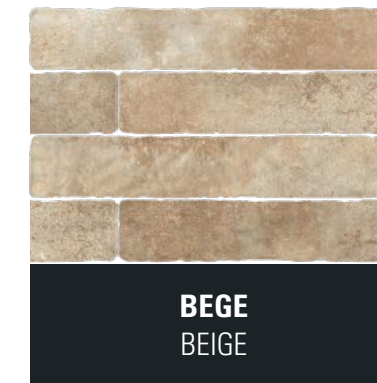

BEGE
BEIGE

8971



COTTO
COTTO

8972

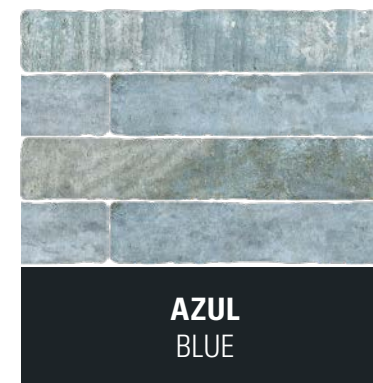

AZUL
BLUE

8973



ANTRACITE
ANTHRACITE

8974

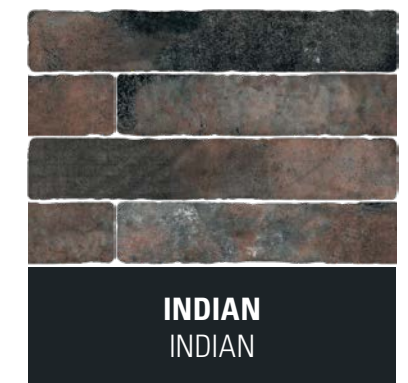

INDIAN
INDIAN

8975

1 FORMATO SIZE



7,5x45 cm 3" x 18"

8 mm 0.32 in

Acabamentos:
Finishings:

NAT Natural



CHROMA

Quando as cores são o elemento-chave, e ainda lhes acrescentamos um formato irreverente, o resultado não poderia ser outro: culmina numa série vibrante e eletrizante.

When colours are the key element, and we add to them an irreverent size, the result could be different: it culminates in a vibrant and electrifying collection.

10 CORES COLOURS



8650



8651



8652



8653

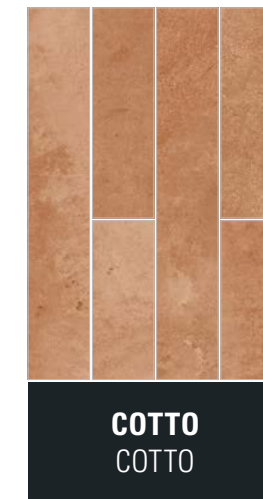

8654



8659

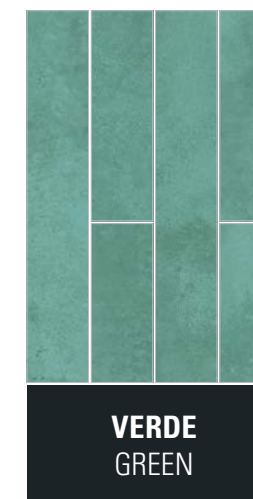

8658



8657

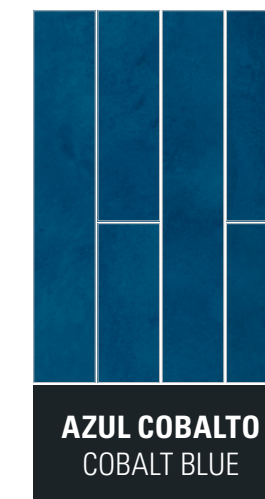

8656

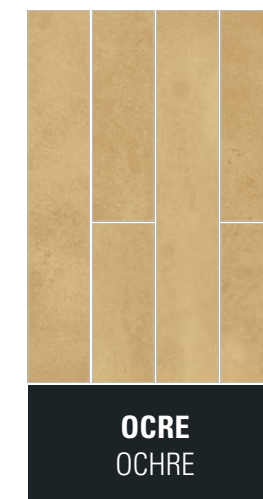

8655

1 FORMATO SIZE



7,5x45 cm 3" x 18"

8 mm 0.32 in

Acabamento:  **Brilhante**
Finishing: Glossy

COLOUR



PORCELANATO VIDRADO
GLAZED PORCELAIN STONEWARE

JUNTOS CUIDAMOS DO FUTURO

A **CINCA – Companhia Industrial de Cerâmica** detém uma forte consciencialização para a temática da preservação do meio ambiente, que se materializa na conceção, na produção e na manutenção do produto ao longo do seu ciclo de vida, incluindo no seu desmantelamento em fim de vida.

Por outras palavras, firmamos o nosso compromisso através da escolha de matérias-primas e de processos eficientes, com a otimização de recursos e análise dos impactos no meio ambiente, na comunidade e no mundo.

Mantemos uma grande preocupação com a eficiência dos nossos processos de produção, nomeadamente com a reciclagem dos subprodutos, a reutilização das águas usadas no processo industrial e no controlo da emissão de gases com efeito de estufa (CO2), sempre alinhado com uma política de economia circular.

A nossa preocupação com a eficiência energética é uma constante, investindo em equipamentos mais eficientes e monitorizando continuamente todo o processo.

TOGETHER WE WILL TAKE CARE OF THE FUTURE

CINCA – Companhia Industrial de Cerâmica has always had a strong environmental preservation and sustainable future awareness, which comes to light in the design, production, and maintenance of its product throughout their life cycle, including its end-of-life disassembly.

In other words, we undertake this through the choice of raw materials and efficient processes, with the optimization of resources and the analysis of impacts on the environment, the community, and the world.

We remain very concerned with our production processes efficiency, including the recycling of by-products, the reuse of industrial process wastewater and the control of greenhouse gas (CO2) emissions, always aligned with a circular economy policy.

Our concern with energy efficiency is relentless, investing in more efficient equipment and continuously monitoring the entire process.



AVISO
OS PRODUTOS INTEGRADOS NESTA BROCHURA SÃO PARA APRESENTAÇÃO NA FEIRA CERSAIE E PODEM NÃO AVANÇAR PARA PRODUÇÃO INDUSTRIAL.
PARA MAIS INFORMAÇÕES, POR FAVOR CONSULTE O SEU AGENTE OU O DEPARTAMENTO COMERCIAL DA CINCA
AS CORES IMPRESSAS PODEM APRESENTAR LIGEIRAS DIFERENÇAS DE TONALIDADE FACE AO PRODUTO.

Copyright CINCA

O conteúdo deste catálogo está protegido pelas disposições do Código do Direito de Autor e dos Direitos Conexos.
A CINCA reserva o direito de alterar ou eliminar, total ou parcialmente, qualquer referência ou especificação técnica contida neste catálogo.
Elaboração: Departamento de Marketing CINCA 2023.



WARNING
PRODUCTS PRESENTED ON THIS BROCHURE ARE FOR CERSAIE EXHIBITION AND MAY NOT EVOLVE TO INDUSTRIAL PRODUCTION.
FOR FURTHER INFORMATION, PLEASE CONTACT YOUR SALES AGENT OR CINCA INTERNATIONAL TEAM.
PRINTED COLOURS ARE AS ACCURATE AS THE LIMITATIONS OF THE PRINTING PROCESS AND MAY DIFFER SLIGHTLY FROM THE PRODUCTS.

Copyright CINCA

The contents of this catalogue are protected by the Author's Code of Copyright and the Connected Rights.
CINCA reserves the right to modify or discontinue, in whole or in part, any reference or technical specification within this brochure.
Developed by CINCA Marketing Department 2023.



CINCA S.A.

Rua Principal, 39
4505-374 Fiães, Portugal
Tel.: 227 476 400
Chamada para a rede fixa nacional.
Email: cinca@cinca.pt

CINCA International

Tel.: +351 227 476 462
Chamada para a rede fixa nacional.
Email: internacional@cinca.pt

CINCA Portugal

Email: portugal@cinca.pt

Showroom Lisboa

Rua Abranches Ferrão, 3B
P - 1600 - 296 Lisboa Portugal
Tel.: 217 210 620
Chamada para a rede fixa nacional.

www.cinca.pt

    [cinca_ceramics](https://www.youtube.com/c/cinca_ceramics)

